

Prodaja in zastopa:  
Matern d.o.o. Morje, morska cesta 6, 2313 Fram  
tel: 02 608 90 10, www.matern.si



# **LARGE SIZE ALPHANUMERICAL DISPLAY PANEL DA1 TYPE**



## **USER'S MANUAL**





# **LARGE SIZE ALPHANUMERICAL DISPLAY PANEL DA1 TYPE**

---

## **USER'S MANUAL**

### **CONTENTS**

<b>1. APPLICATION</b> .....	<b>5</b>
<b>2. DISPLAY PANEL SET</b> .....	<b>5</b>
<b>3. BASIC REQUIREMENTS, OPERATIONAL SAFETY</b> .....	<b>5</b>
<b>4. DESIGN DESCRIPTION AND INSTALLATION</b> .....	<b>6</b>
<b>5. ELECTRICAL CONNECTIONS</b> .....	<b>7</b>
<b>6. DA1 DISPLAY PANEL FUNCTIONS</b> .....	<b>8</b>
6.01 CONNECTION CONFIGURATION.....	8
6.02 CHANGE OF PANEL CONNECTION PARAMETERS WITH THE COMPUTER.....	8
6.03 DISPLAY PANEL IDENTIFICATION .....	9
6.04 TEXTUAL TABLES .....	9
6.05 SCROLLING .....	10
6.06 GRAPHICS .....	10
6.07 PRESENTATION MODE .....	10
6.08 REAL-TIME CLOCK.....	11
6.09 DATA READ-OUTFROM EXTERNAL DEVICES .....	12
6.10 DIAGNOSTIC REGISTERS .....	12
6.11 BRIGHTNESS CONTROL .....	13
<b>7. INTERFACE</b> .....	<b>14</b>
7.1 REGISTER MAP OF THE DA1 CONTROLLER.....	14
<b>8. TECHNICAL DATA</b> .....	<b>19</b>
<b>9. ORDERING CODES</b> .....	<b>20</b>
<b>10. BEFORE A FAILURE WILL BE DECLARED</b> .....	<b>20</b>
<b>11. MAINTENANCE AND WARRANTY</b> .....	<b>21</b>



## 1. APPLICATIONS

Large size alphanumerical textual display panels with changing information contents are destined to display messages inside buildings and can be applied:

- in selling points to display publicity, price lists, information for customers,
- in banks to display information about: exchange rate, interest rate, publicity, information for customers,
- in concert halls, museums, as information about repertoire, informational or welcoming boards for visitors,
- as informational boards in different offices (e.g. Marketing Departments),
- in railway and bus stations or airports as informational boards for travellers,
- in office building halls, as publicity or informational boards destined to display publicity or parameters, e.g. about the weather,
- in office buildings of production plants to display information about the production state (e.g. number of produced pieces, temperature, pressure, etc.),
- in the judiciary as notice-boards.

Situated in a visible place, information helps in the efficient work in industrial communication, logistics, automation, selling and control technology.

These alphanumerical display panels are offered in three colours of the read-out field: red, green or yellow. The DA1 display panels co-operate with external measuring devices equipped with RS-485 interface with MODBUS RTU protocol. Is it possible to visualise the technological process and transmit messages from devices. The basic version of these displays signs includes two lines of 20 or three lines of 24 characters in the textual version or a graphical field of 16 x 120 points or 32 x 144 points.

After agreement with customers, custom-made display panels can be designed for special applications.

## 2. DISPLAY PANEL SET

The display panel set is composed of:

- Display panel with changing information contents, ..... 1 pc
- „DA1-configurator” software ..... 1 pc
- assembly jigs ..... 2 pcs
- user's manual ..... 1 pc
- warranty card ..... 1 pc

## 3. BASIC REQUIREMENTS, OPERATIONAL SAFETY

Symbols located in this service manual mean:



### **WARNING!**

Warning of potential, hazardous situations. Especially important, one must acquaint with this before connecting the display panel. The non-observance of notices marked by these symbols can occasion severe injuries of the personnel and the damage of the display panel.



### **CAUTION!**

Designates a general useful note. If you observe it, handling of the display panel is made easier. One must take note of this, when the panel is working inconsistently to the expectations.

Possible consequences if disregarded !

In the security scope, the display panel fulfils the requirements of the EN 61010 -1 standard

Remarks concerning the operator safety:



### **1. General**

- The DA1 textual display panel is destined to be installed according its appropriation. Do not install the display panel on the outside of buildings.
- Non-authorized removal of the required housing, inappropriate use, incorrect installation or operation creates the risk of injury to personnel or damage to equipment. For more detailed information please study the user's manual.
- All operations concerning transport, installation, and commissioning as well as maintenance must be carried out by qualified, skilled personnel and national regulations for the prevention of accidents must be observed.
- According to this basic safety information, qualified, skilled personnel are persons who are familiar with the installation, assembly, commissioning, and operation of the product and who have qualifications necessary for their occupation.

### **2. Transport, storage**

Please observe the notes on transport, storage and appropriate handling.

Observe the climatic conditions given in Technical Data.

### **3. Installation**

- The display panel must be installed according to the regulation and instructions given in this User's Manual.
- Ensure proper handling and avoid mechanical stress.
- Do not bend any components and do not change any insulation distances.
- Do not touch any electronic components and contacts.
- The display panel may contain electrostatically sensitive components, which can easily be damaged by inappropriate handling
- Do not damage or destroy any electrical components since this might endanger your health!

### **4. Electrical connection**

- Before switching the display panel on, one must check the correctness of connection to the network.
- In case of the protection terminal connection with a separate lead, one must remember to connect it before the connection of the display panel to the mains.

- When working on live components, the applicable national regulations for the prevention of accidents must be observed.
- The electrical installation must be carried out according to the appropriate regulations (cable cross-sections, fuses, PE connection). Additional information can be obtained from the user's manual.
- The documentation contains information about installation in compliance with EMC (shielding, grounding, filters and cables). These notes must be observed for all CE-marked products.
- The manufacturer of the measuring system or installed devices is responsible for the compliance with the required limit values demanded by the EMC legislation.
- The RS-232 wire serves exclusively to connect the PC computer to the display panel configuration
- Non-utilized wires and connections must be secured against an accidental short-circuit.

**5. Operation**

- Measuring systems including DA1 display panels must be equipped with protection devices according to the corresponding standard and regulations for prevention of accidents.
- After the display panel has been disconnected from the supply voltage, live components and power connections must not be touched immediately because capacitors can be charged.
- The housing must be closed during operation.

**6. Maintenance and servicing**

- Please observe the manufacturer's documentation.
- Read all product-specific safety and application notes in this user's manual.
- Before taking the display panel out, one must turn the supply off.
- The removal of the display panel housing during the warranty period may cause its cancellation

**4. DESIGN DESCRIPTION AND INSTALLATION**

The display panel housing is made of aluminium.

The safety degree ensured by the housing is IP40.

Display panel dimensions depending on versions are presented in the table 1.

The display panel has two assembly jigs enabling the suspension or the assembly on a wall with the angle adjustment.

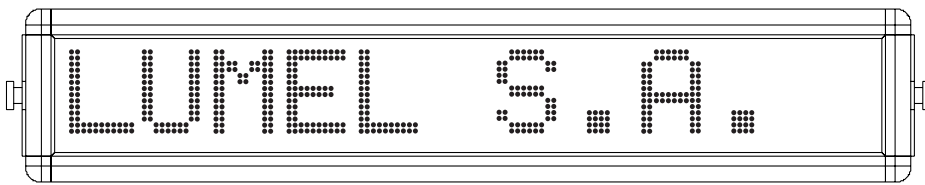

Fig. 1. DA1 display panel

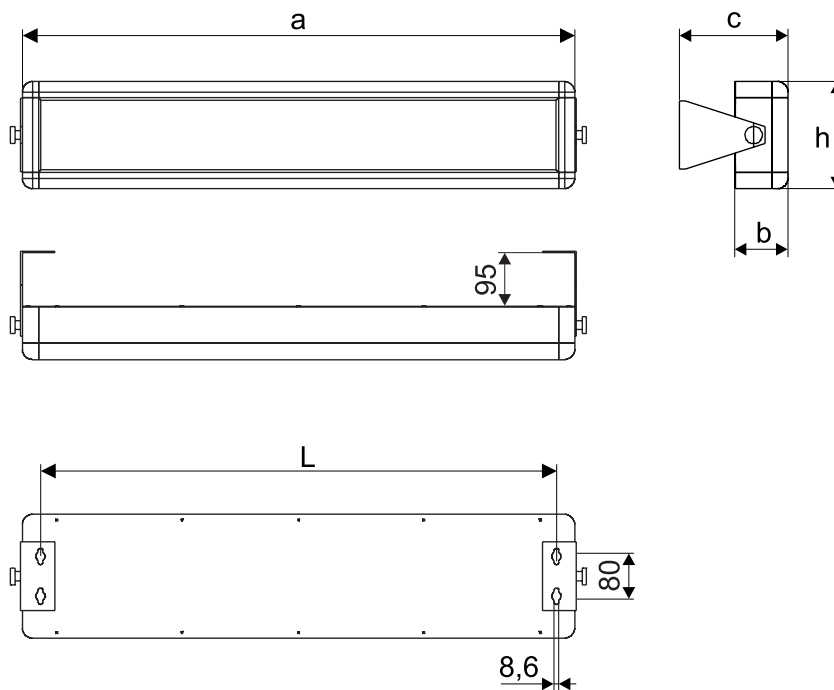

Fig. 2. Display panel dimensions and arrangement of holes and assembly

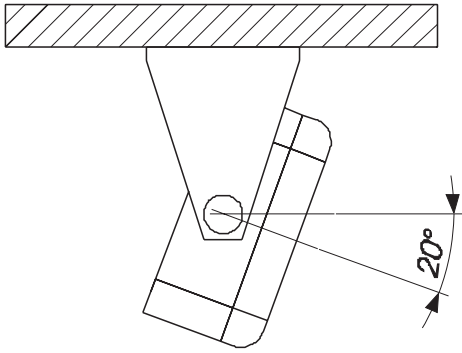

Fig. 3 Panel suspension

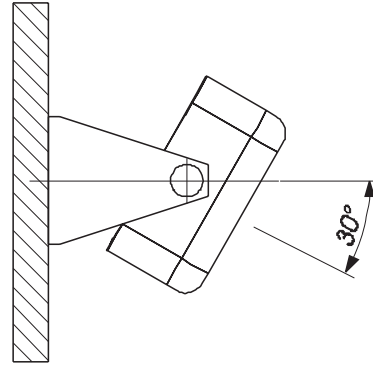

Fig. 4. Panel fixing on a wall

Table 1

Panel type	Read-out field	Panel overall dimensions [mm]	Dimensions of assembly [mm]
01	2 lines of 20 characters	a = 971, b = 93.5, h = 218	c = 190.5, L = 907
02	3 lines of 24 characters	a = 1151, b = 93.5, h = 308	c = 190.5, L = 1108
03	graphics 16 x 120 points	a = 971, b = 93.5, h = 218	c = 190.5, L = 907
04	graphics 32 x 144 points	a = 1151, b = 93.5, h = 308	c = 190.5, L = 1108

## 5. ELECTRICAL CONNECTIONS

Electrical connections must be carried out according to the fig. 5

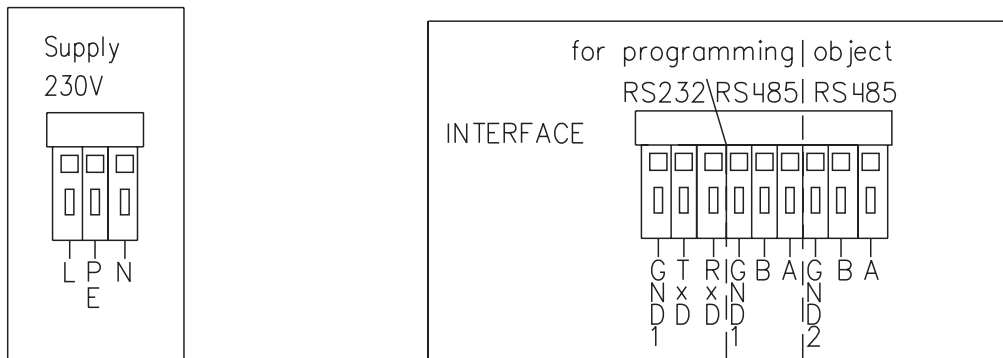

Fig.5 Electrical connections.

In order to facilitate the assembly, all terminals were additionally described on the housing.



to make the interface installation, a double twisted wire in a shield is recommended.

Connect the shield with the PE terminal.

### Notice:

All display panel communication connections should be made when the supply is turned off.

Before turning the display panel supply on, it is recommended to check the assembly correctness in respect of terminal colouring preservation and corresponding signals according to the above

See electrical connections on the fig. 5.,

## 6. FUNCTIONS OF THE DA1 DISPLAY PANEL

### 6.01 Connection configuration - setting of serial port parameters

The configuration of transmission parameters is carried out in the dialog window presented on the fig. 6. The display panel has a wide range of serviced baud rates for both communication interfaces: from 2400 b/s to 9600 b/s.

In order to establish a communication with the display panel, the User must define:

- the serial port which the display panel is connected to,
- the type of the transmission frame,
- the connection baud rate,
- the timeout - waiting time for the answer,
- the DA1 display panel address.

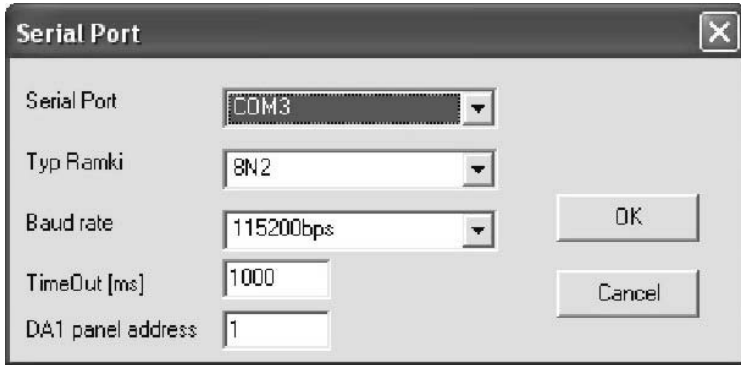
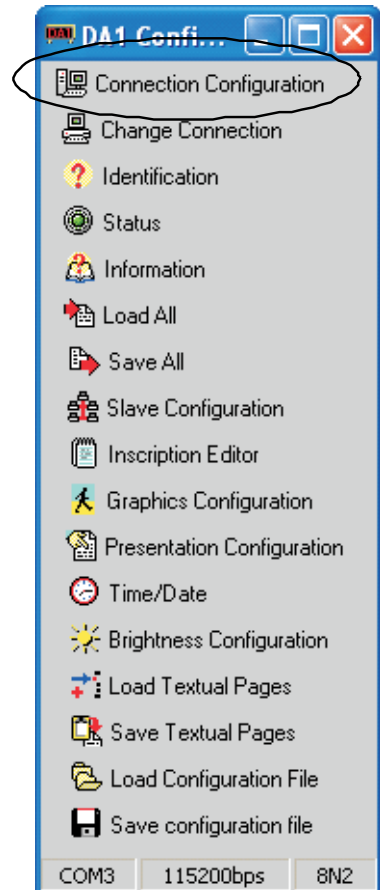

Fig. 6. Configuration of the serial port

The introduction of incorrect values is signalled by the software with the demand to correct values of the mistakenly given parameter.

**Notice: The display panel is significantly configured for the work with the 8n2 frame and the baud rate 9600 b/s. The significant panel address is address 1.**



### 6.02. change of display panel connection parameters with the computer

The change of connection parameters between the computer and the display panel can be carried out only when the serial port is correctly configured in the computer.

In order to change transmission parameters, one must start the „Change Connection” dialog, then the dialog shown on the fig. 7 will be displayed on the screen.

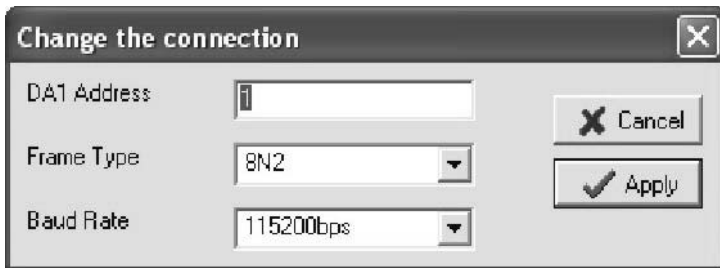
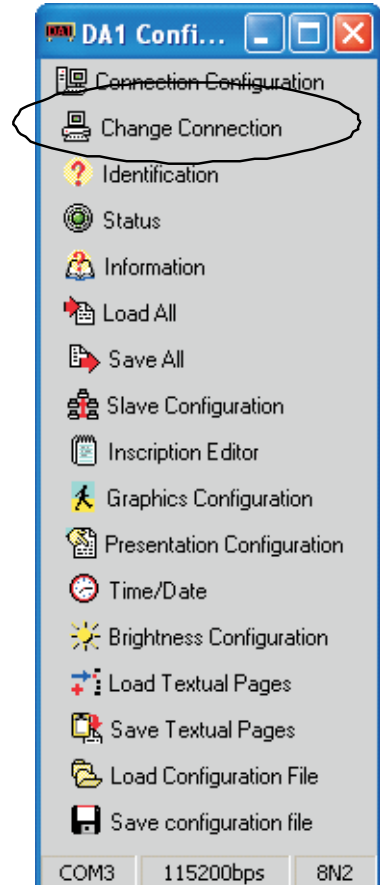

Fig. 7. Change of transmission parameters



One must give required transmission parameters (new transmission parameters) in the dialog. After pressing the push-button **Apply**, the change of transmission parameters follows, that will be confirmed by the display of the panel identifier.



### 6.03 Display panel identification

The display panel identification serves to display information about the display panel and check the connection with the display panel. For the identification, the 17 MODBUS function is used.

The pressure of the „Identification” push-button causes the read-out of data from the DA1 display panel and the display of the information window (only in the case when transmission errors did



Fig. 8 Identification window

The response to the identification command causes the transmission of the identifier by DA1 and the display panel dimensions in number of matrix in horizontal and vertical positions.

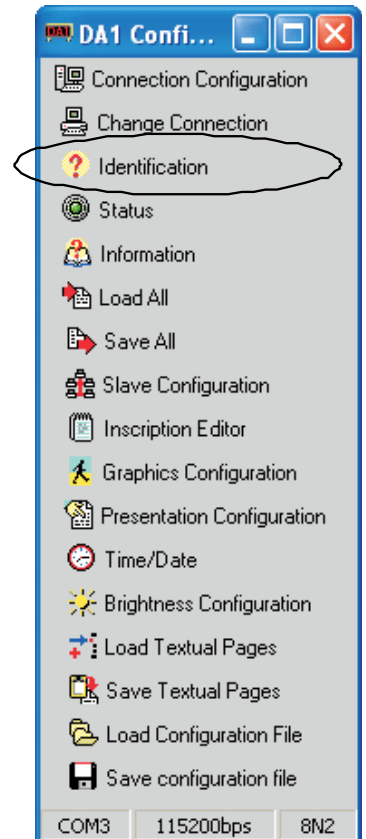

### 6.04. Textual tables

the display panel internal memory enables the storage of 115 tables of 200 characters, from which, 15 tables are stored in the non-volatile memory of the display panel.

One must use the „DA1\_ Configurator” software to configure textual tables. The edition of inscriptions takes place in the „Page Editor” dialog window presented on the fig.9.

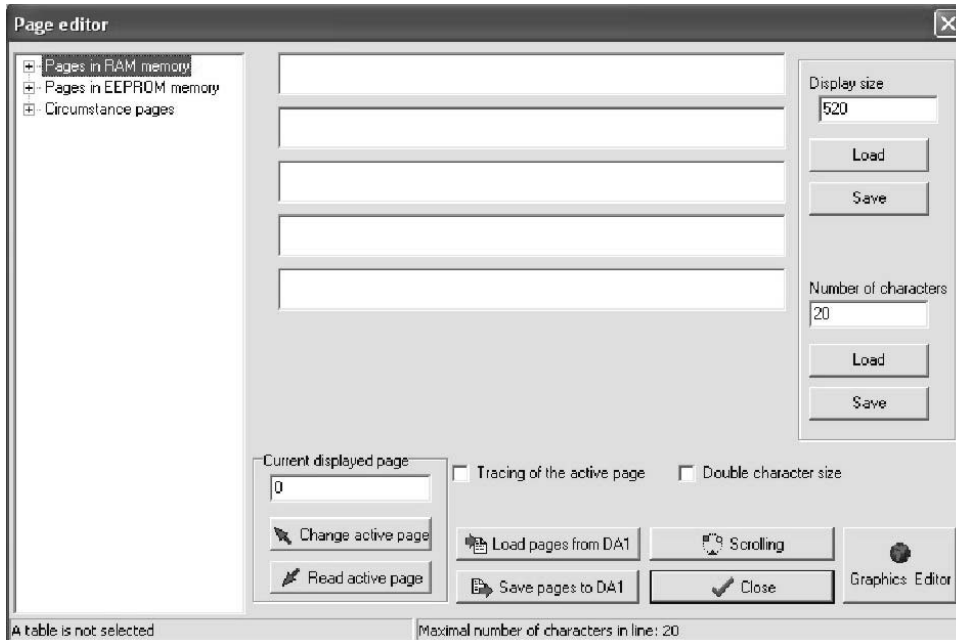
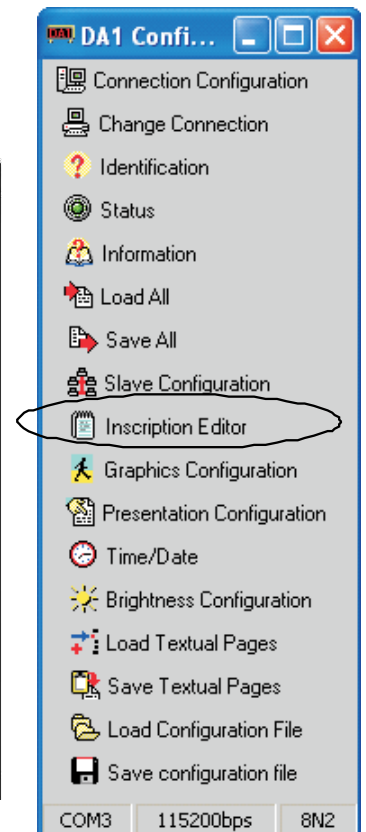

Fig. 9 Editor of inscriptions



In the edition window, the user can introduce texts on any pages, configure circumstantial messages, and also change and read out the currently displayed page. During the text edition it is also possible to introduce the virtual display panel dimension and switch on to the configuration window of the scrolling function.

The virtual space is understood as the display panel dimension in the number of characters in the line, which can be higher than the physical number of characters displayed simultaneously. Characters being beyond the visible space can be displayed using the function of line scrolling. There is also in the page editor the possibility to read out and write textual pages directly into/from the DA1 display panel.

**Pages in the EEPROM memory:** One can write into the non-volatile panel memory, 10 tables of 200 characters which are stored in spite of breaks in the supply.

**Circumstantial pages:** The panel allows the storage of 5 circumstantial messages in the non-volatile memory, displayed in the given time (date) and in specified hours defined by the User.

### 6.05. Text scrolling

Each of the displayed line can be scrolled in order to increase the number of displayed data.

The scrolling direction is settled for the whole display panel. The text scrolling is possible in directions: right, left or alternately ( i.e. after scrolling the text in one direction, the scrolling direction will be changed automatically).

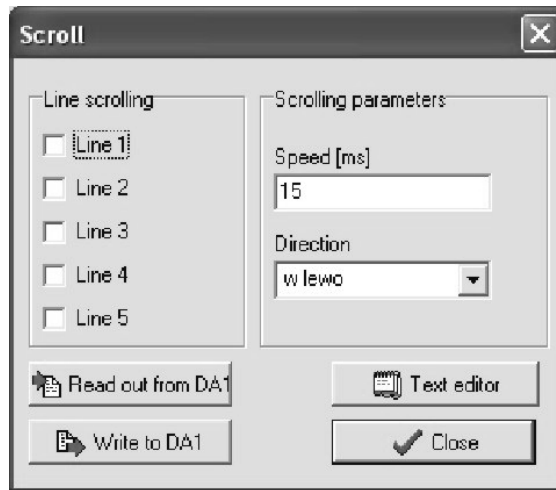

### 6.06. Graphics

The display panel enables the write of 10 graphical tables with the maximal resolution of 4800 points, which can be increased to 9600 points in case of turning the scrolling function on. The standard DA1 - 04 display panel has 4608 points.

One can prepare the graphical picture in the .bmp format in any graphical program, next by means of the „DA1-Configurator” software, program the DA1 display panel. The graphical picture can also be an element in the presentation mode. The configuration of graphical tables displayed through the display panel is carried out in the graphics editor presented on the fig. 10.

In order to attribute the graphics to the selected page, the User must choose the required page, and next press the assign push-button , then the attribution of the indicated graphical file to the given graphical page takes place. During the attribution of the graphical file, the conversion of the file dimension on the declared DA1 display panel dimension follows.

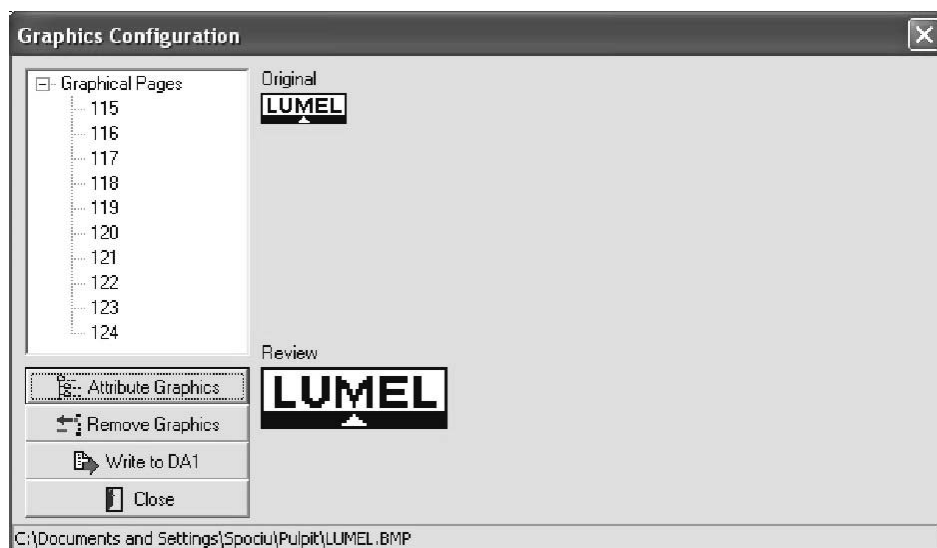
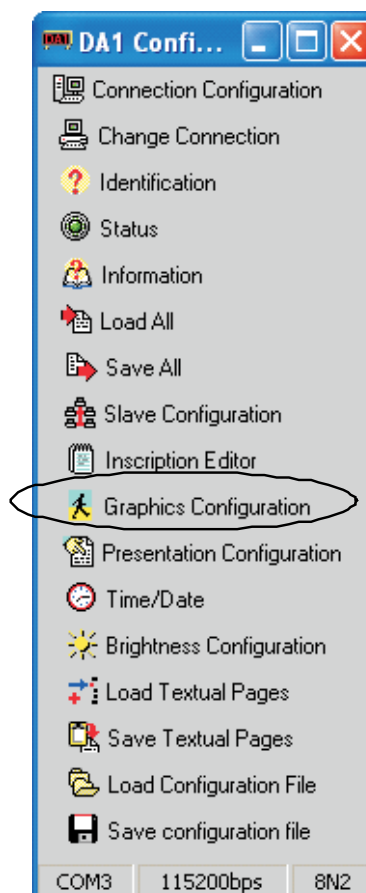

Fig. 10. Graphics configuration



The transmission of the graphical page to the controller is carried out through the „Write to DA1” push-button.

### 6.07. Presentation mode

The DA1 display panel has a special working mode, which is destined to display in a cyclical way, stored textual and/or graphical pictures. The display time, number of displayed screens and the sequence are defined by the User by means of the „DA1-Configurator” software.

The configuration of the automatic presentation is carried out in the „Editor of Automatic Presentation” dialog window presented on the Fig 11. The addition of the page to the presentation is carried out by marking the required page on the left window of the page list and pressing the „Add to the list” push-button, what causes the addition of the indicated page to the presentation list, on its end. The change of the page position in the presentation is carried out by means of up and down push-buttons.

The indication of any page causes the display of its review.

The clearing of the presentation list is carried out by „Remove from the list” (Remove of a single position) and „Clear the list” (remove of all elements from the list) push-buttons.

During the presentation configuration, one must settle the switching time between successively displayed pages. The review of the created presentation enables the observation of inscriptions displayed on the display panel or also the simulation of the review on the PC computer.

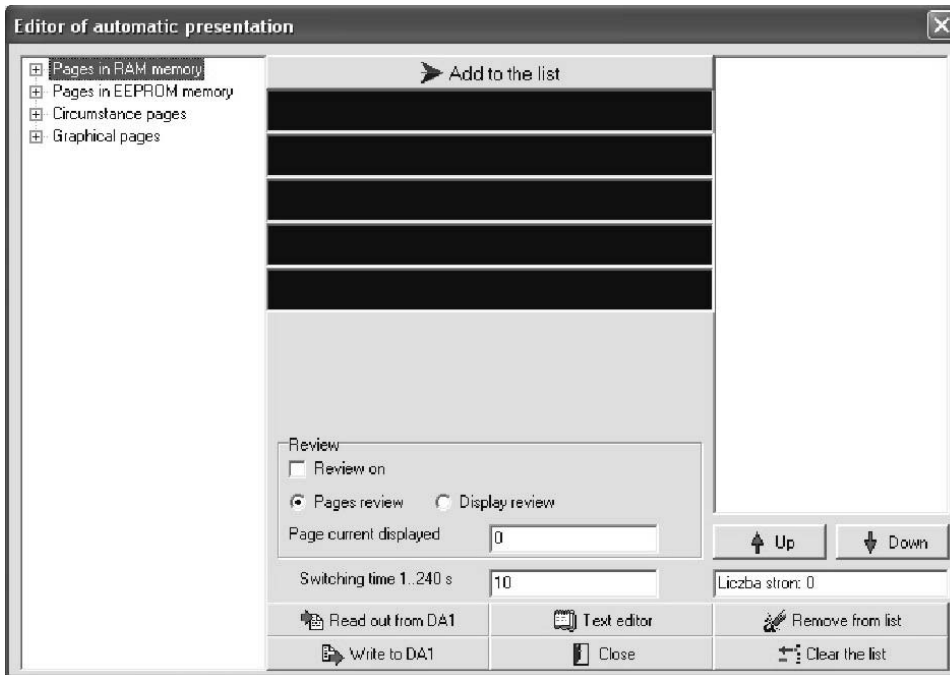
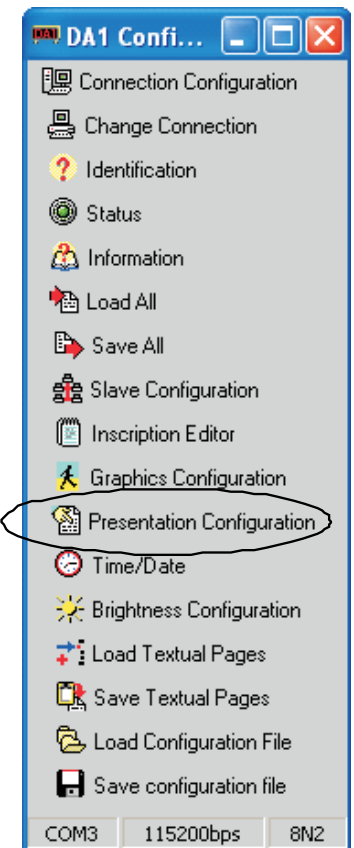

Fig. 11. Configuration of the presentation



### 6.08. The real-time clock

The DA1 display panel has an internal real-time clock with the function to support the clock in case of any supply decay and change automatically the summer time into the winter time, and inversely. The „DA1- Configurator” software allows to program the position and format of the time and date if we want to place these quantities on the display field.

The setting of the time and date, and the position of the automatic display of time and/or date with the displaying format can be performed in the „Time and Date” dialog window.

In this window, two overlaps are placed: Time and Data, and Displaying of time and data.

One can set the time and date in three ways:

- by the manual writing of time and date and pressing the „Write to DA1” push-button,
- by pressing the „Synchronise” push-button, what occasions the transmission of the time and date collected from the PC computer, to the display panel.
- The pressure of the „Synchronise Sec” push-button, in order to synchronise the time and date with the accuracy of 1 sec - the choice of this option, causes in the clock, the start of the clock system countdown program, till the appearance of the 0 sec. indication in the computer, when the transmission of the time to the panel takes place.

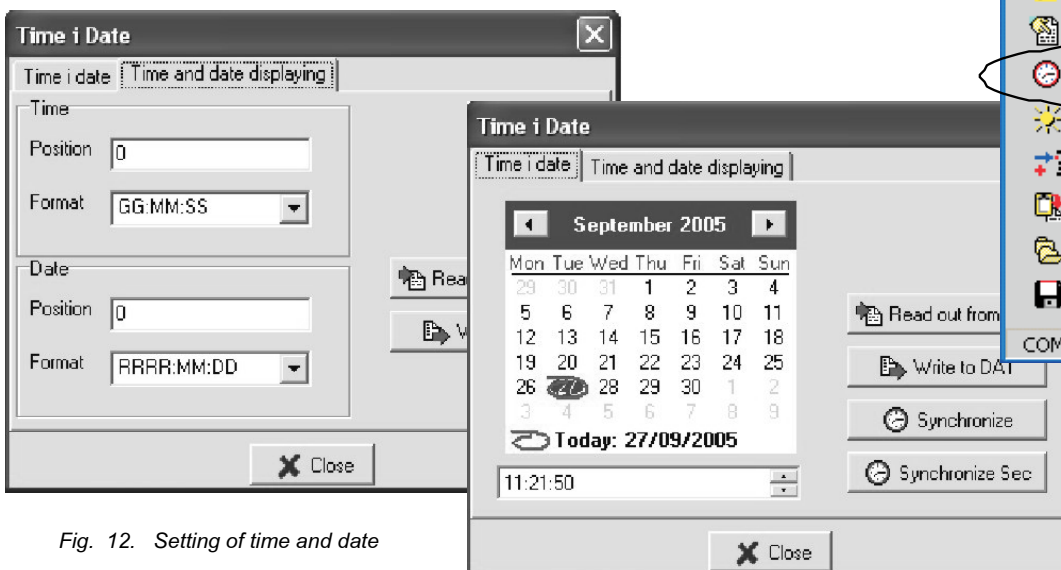

Fig. 12. Setting of time and date

Fig. 13. Configuration of time and data displaying

### 6.09 Read-out of data from external devices

An additional RS-485 interface with the MODBUS RTU protocol is forecasted for data read-out from external devices.

The configuration of transmission parameters and the configuration of read-out parameters to/from external devices is carried out through the pressure of the „Slave configuration” push-button. In the displayed dialog, the User must introduce transmission parameters on the object side and give data parameters read out from the devices.

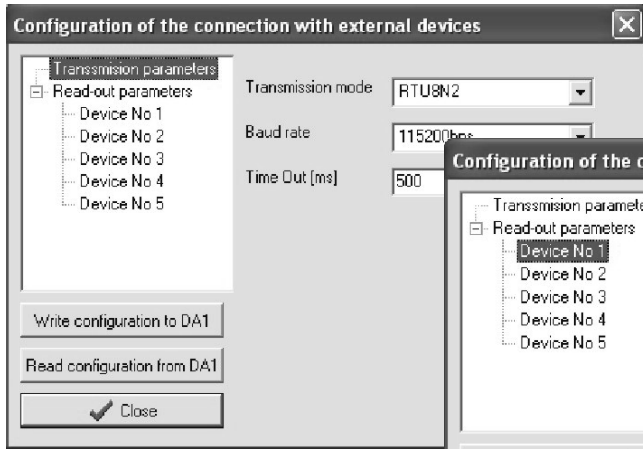

Fig. 14. Configuration of transmission parameters from slave devices

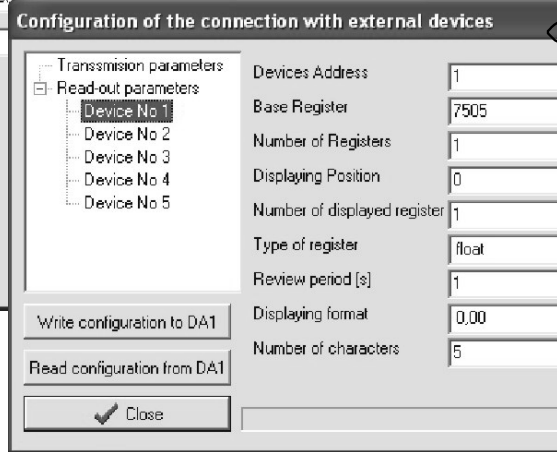
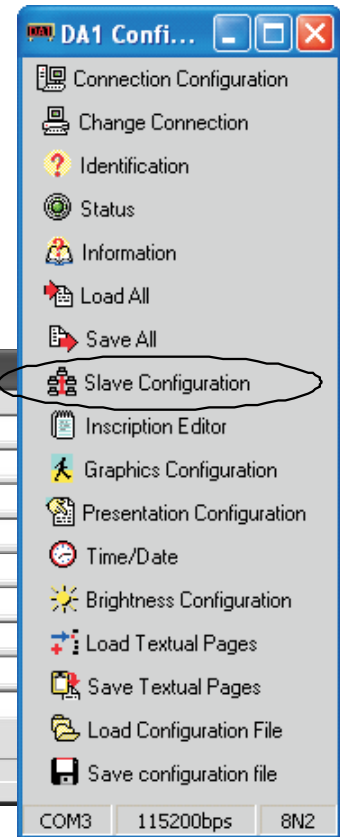

Fig. 15. Configuration of data read out from slave devices



The configuration of read out parameters (displayed data) includes following parameters:

- Device address - it is the device address in the MODBUS network, which data are to be displayed from,
- Base register - defines the register in the device, which the data read-out is to begin from,
- Number of registers - defines how many registers is to be read out from the device. The number of registers must be included in the range from 1 to 10.
- Displaying position - defines the position, which data is to be displayed on, The 0 value causes the read-out turn off
- Number of the displayed register - defines, which from the read out register series is to be displayed on the panel,
- Register type - defines what type of registers are included in the device which will be performed the read-out from,
- Review period - defines the period of request transmission by the DA1 panel to the slave device,
- Displaying format - defines the accuracy which are to be displayed data read out from external devices,
- Number of characters - defines the number of characters destined for displaying of the given value, after exceeding this value, the display panel is to signal the error.

### 6.10. Diagnostic registers

Built-in diagnostic registers inform about the controller and event states. After starting the display panel, diagnostic messages are displayed. The „DA1-Configurator” program enables the review of diagnostic registers.

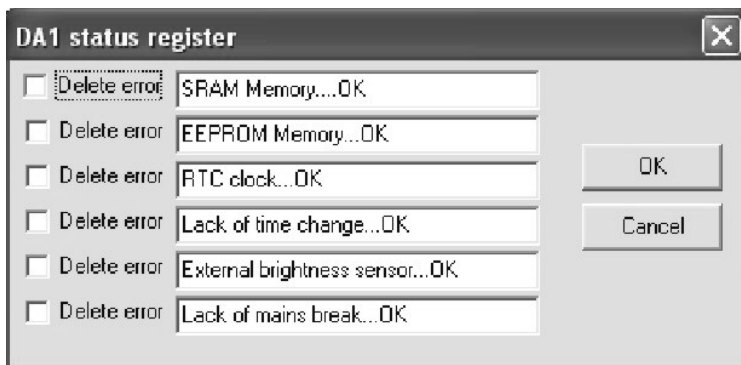
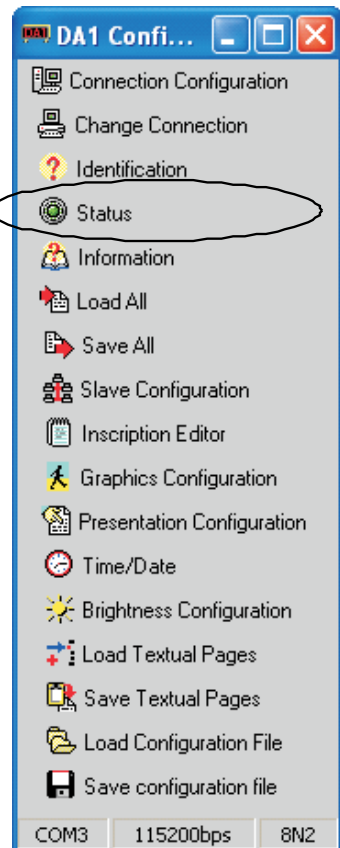

Fig. 16. Status window



## 6. 11. Brightness control

The DA1 display panel enables to define brightness changes. In order to define the brightness, one must introduce the starting time of the day and the starting time of the night and define the brightness level for the day and night expressed as the percentage of the maximal brightness. After introducing of the mentioned above parameters, one can made the write of settings for DA1 by pressing the „Write settings” push-button. During the display panel operation with a lighting sensor, one must mark the „ turn the external brightness sensor on”, then on the display panel, fields to introduce the minimal and maximal brightness level which the panel is to reach at external lighting (corresponding to minimal and maximal) will be displayed.

The view of the dialog window with the external lighting sensor turned on is presented on the fig. 18.

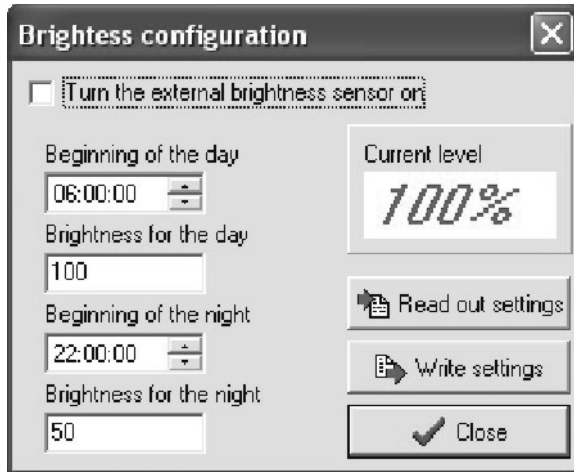

Fig. 17. Setting of the brightness on the base of time

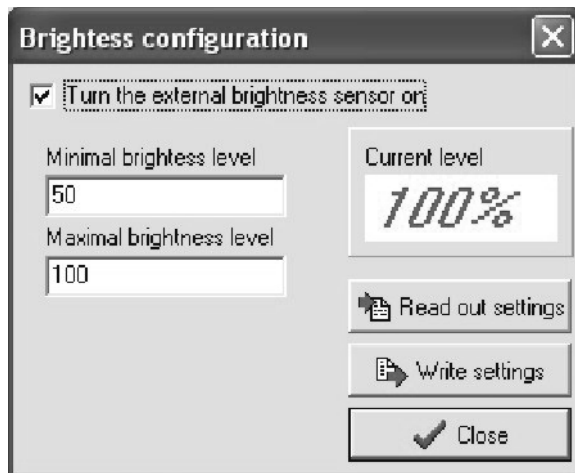
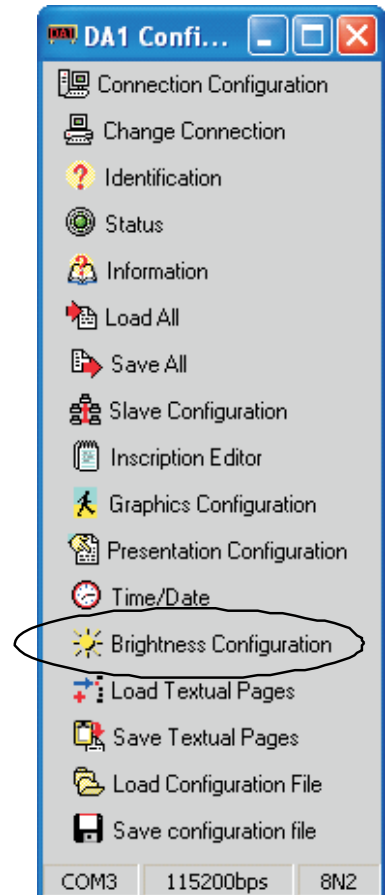

Fig. 18. Setting of the brightness on the base of the lighting sensor



## 7. INTERFACE

The display panel has the possibility to communicate with the PC computer through the RS-232 or RS-485 serial interface. The communication protocol MODBUS RTU is implemented in the panel. Working modes are: RTU8N2, RTU8N1, RTU8E1, RTU8O1.

The baud rate englobes the range from 2400 b/s to 115200 b/s. Register values are of unsigned integer type. The word is placed in the register in the sequence: older byte, younger byte

### 7.1. Register map of the DA1 controller

Table 2

Register address	Operations	Range	Description
4000	RW	1... 247	Interface number 1 address - User's interface
4001	RW	0... 3	Working mode of the interface number 1: 0: RTU 8N1 1: RTU 8N2 2: RTU 8E1 3: RTU 8O1
4002	RW	0... 9	Baud rate of the interface number 1[b/s]: 0 - 2400; 1 - 4800; 2 - 9600; 3 - 14400; 4 - 19200; 5 - 28800; 6 - 38400; 7 - 57600; 8 - 76800; 9 - 115200
4003	RW	1... 50	Waiting time of the slave device response for the port 2, expressed as the multiple of 100 ms
4004	RW	0... 3	Working mode of the interface number 2: 0: RTU 8N1 1: RTU 8N2 2: RTU 8E1 3: RTU 8O1
4005	RW	0... 9	Baud rate of the interface number 2[b/s]: 0 - 2400; 1 - 4800; 2 - 9600; 3 - 14400; 4 - 19200; 5 - 28800; 6 - 38400; 7 - 57600; 8 - 76800; 9 - 115200
4006	RW	0... 2359	Current time in the format hour.100 + minutes. The time write causes the automatic reset of seconds.
4007	RW	1... 99	Current year in the RR format.
4008	RW	101... 1231	Current date in the format month.100 + day.
4009	RW	1... 100%	Panel brightness level for the day. Used at turned lighting sensor off. Brightness control in the time base.
4010	RW	1... 100%	Panel brightness level for the night. Used at turned external lighting sensor off. Brightness control in the time base
4011	RW	0... 2359	Hour of the day beginning - Beginning of the day for the time brightness control. The time in the format hour.100 + minutes.
4012	RW	0... 2359	Hour of the night beginning - Beginning of the night for the time brightness control.
4013	RW	1... 415	The real dimension in the panel is expressed as the number of matrix in vertical - y_matrix, and the number of matrix in horizontal - x_matrix. The dimension is calculated as: Y_matrix.100 + x_matrix <b>Note:</b> one matrix ie equal 8 x 8 points.
4014	RW	x_matrix... X_MAX	Virtual dimension of the display panel. Expressed as the number of matrix in vertical . character fields situated in the virtual area are display only during the scrolling. X_MAX depends on the number of matrix x_max and y_max, and the whole number of characters during the smultaneous display cannot exceed 200 characters.
4015	RW	0, 1	External lighting sensor: 0 - lack 1 - installed
4016	RW	1... 100%	Minimal brightness level - defines the minimal brightness level working with the external lighting sensor.
4017	RW	1... 100%	Maximal brightness level - defines the maximal brightness level when working with the external lighting sensor.
4018	RW	0, 1	Diagnostic messages: 0 - OFF; 1 - ON. The message turn on causes the display of diagnostic messages during the panel start.
4019	R	0... 100%	Current level of the panel brightness.
4020	RW	1... 1000	Scrolling speed of the text in ms - shift time of 1

4021	RW	0... 2	Direction of the panel scrolling: 0 - to the left 1 - to the right 2 - alternately
4022	RW	0... 31 (00... 1F)h	Permission to scroll the line. The setting of the bit on the appropriate position causes the scrolling turn of the given line on. The younger bit corresponds to the first line of the display panel.
4023	RW	0... 529	Automatic display of the time. The turn of the function on, causes the display of the current time on the position x,y: Value 0: the function is OFF Value y+100+ x > 0 - the function is ON
4024	RW	0... 1	Time format: 0 - GG:MM:SS; 1 - GG:MM.
4025	RW	0... 529	Automatic display of the date. The turn of the function o, causes the display of the current date on the position x,y: Value 0: the function is OFF Value y+100+ x > 0 - the function is ON
4026	RW	0... 3	Date format: 0 - RRRR-MM:DD; 1 - RR-MM-DD; 2 - DD:MM:RRRR; 3 - DD:MM:RR.
4027	RW	0, 1	Global permission to display circumstantial messages: 0 - messages are OFF 1 - messages are ON
4028	RW	0... 240	Interval between successively displayed screens at work in the automatic presentation mode.
4029	RW	0... 114	Number of the first screen - presentation mode
4030	RW	0... 114	Number of the second screen - presentation mode
.	.	0...114	Number ... screen - presentation mode
4144	RW	0... 114	Number 115 of the screen - presentation mode
4145	RW	1... 115	Number of screens displayed cyclically . 0 - presentation mode is OFF. The screen defined by the register number 4146 is displayed.
4146	RW	0... 114	Currently displayed textual panel
4147	RW	0... 1231	Date of the circumstantial message number 1: 0 - message is OFF; month.100 +day > 0 - message is active.
4148	RW	0...1231	Date of the circumstantial message number 2
4149	RW	0...1231	Date of the circumstantial message number 3
4150	RW	0...1231	Date of the circumstantial message number 4
4151	RW	0...1231	Date of the circumstantial message number 5
4152	RW	0... 2359	Hour to start the display of the circumstantial message number 1 in the format hour.100 + minutes.
4153	RW	0...2359	Hour to start the display of the circumstantial message number 2
4154	RW	0...2359	Hour to start the display of the circumstantial message number 3
4155	RW	0...2359	Hour to start the display of the circumstantial message number 4
4156	RW	0...2359	Hour to start the display of the circumstantial message number 5
4157	RW	0...2359	Hour to end the display of the circumstantial message number 1 in the format hour.100 + minutes.
4158	RW	0...2359	Hour to end the display of the circumstantial message number 2
4159	RW	0...2359	Hour to end the display of the circumstantial message number 3
4160	RW	0...2359	Hour to end the display of the circumstantial message number 4
4161	RW	0...2359	Hour to end the display of the circumstantial message number 5
4162	RW	0... 114	Number of the textual display panel: 0...99 - textual tables placed in the RAM memory; 100...109 -textual tabtes placed In the EEPROM memory 110...114 - circumstantial tables.



Register address	Operations	Range	Description
4163	RW	0... 65535	Character data in the shape of ASCII codes in the format: Character 1 - 8 older word bits Character 2 - 8 younger word bits
4164	RW	0... 65535	Character 3   character 4
4165	RW	0... 65535	Character 5   character 6
⋮	RW	0... 65535	⋮
4263	RW	0...65535	Character199   character 200
4264	RW	0, 1	Character dimension: 0 - single (5x8); 1 - dual (10x16)
4265	RW	0... 64512	Status register, bits present event flags or errors: Bit 15 - SRAM memory error Bit 14 - EEPROM memory error Bit 13 - setting error of the RTC clock or unreliable settings; Bit 12 - Summer/winter time was changed or inversely; Bit 11 - Error of the external lighting sensor (setting only in the case when the sensor is turned on). Bit 10 - Break of the supply - the flag is set in case of supply decay.
4266	RW	0... 65535	The register is used - The data in the register is stored in the EEPROM memory. The write of the data causes the page refresh. Variable for future applications.
4267	RW	0... 65535	Variables preserve information about the character dimensions on pages. Successive variables in the register word inform about the character dimensions on the given page. The set bit („1”) means characters of double height.
...	...		
4274	RW		

Registers of data read-out configuration from external devices.

Table 3

Register address	Operations	Range	Description
4300	RW	0... 529	Device No 1: The result display position read out from the slave device register. The write of the value 0 causes the read-out stoppage (display) of the read-out result. The display position is defined as Y.100 + x.
4301	RW	1...247	Device No 1: Slave device address
4302	RW	0...65535	Device No 1: Base address
4303	RW	1...10	Device No 1: Number of the register to display
4304	RW	1...10	Device No 1: Number of the register to display
4305	RW	0... 6	Device No 1: Register type: 0 - Variable of char type 1 - Variable of unsigned char type 2 - variable of integer type 3 - Variable of unsigned integer type 4 - Variable of long type 5 - Variable of unsigned long type 6 - Variable of float type
4306	RW	1... 60	Device No 1: review period in seconds. Defines the polling frequency of the slave device.
4307	RW	0... 3	Device No1: Number of places after the decimal point in the displayed result. 0 - lack of vdecimal point; 1 - one place after the decimal point; 2 - two places after the decimal point; 3 - three places after the decimal point.
4308	RW	3... 39	Device No 1: Forecasted number of characters placed on the display during the result display. Serves to clear the display in case of the decrease of number of digits in the displayed result.
4309	RW	0... 529	Device No 2: The result display position read out from the slave device register. The write of the value 0 causes the read-out stoppage (display) of the read-out result. The display position is defined as Y.100 + x.
4310	RW	1...247	Device No 2: Slave device address
4311	RW	0...65535	Device No 2: Base address
4312	RW	1...10	Device No 2: Number of the register to display
4313	RW	1...10	Device No 2: Number of the register to display



4314	RW	0... 6	Device No 2: Register type: 0 - Variable of char type 1 - Variable of unsigned char type 2 - variable of integer type 3 - Variable of unsigned integer type 4 - Variable of long type 5 - Variable of unsigned long type 6 - Variable of float type
4315	RW	1... 60	Device No 21: review period in seconds. Defines the polling frequency of the slave device.
4316	RW	0... 3	Device No21: Number of places after the decimal point in the displayed result. 0 - lack of vdecimal point; 1 - one place after the decimal point; 2 - two places after the decimal point; 3 - three places after the decimal point.
4317	RW	3... 39	Device No 2: Forecasted number of characters placed on the display during the result display. Serves to clear the display in case of the decrease of number of digits in the displayed result.
4318	RW	0... 529	Device No 3: The result display position read out from the slave device register. The write of the value 0 causes the read-out stoppage (display) of the read-out result. The display position is defined as $Y.100 + x$ .
4319	RW	1...247	Device No 3: Slave device address
4320	RW	0...65535	Device No 3: Base address
4321	RW	1...10	Device No 3: Number of the register to display
4322	RW	1...10	Device No 3: Number of the register to display
4323	RW	0... 6	Device No 3: Register type: 0 - Variable of char type 1 - Variable of unsigned char type 2 - variable of integer type 3 - Variable of unsigned integer type 4 - Variable of long type 5 - Variable of unsigned long type 6 - Variable of float type
4324	RW	1... 60	Device No 3: review period in seconds. Defines the polling frequency of the slave device.
4325	RW	0... 3	Device No3: Number of places after the decimal point in the displayed result. 0 - lack of vdecimal point; 1 - one place after the decimal point; 2 - two places after the decimal point; 3 - three places after the decimal point.
4326	RW	3... 39	Device No 3: Forecasted number of characters placed on the display during the result display. Serves to clear the display in case of the decrease of number of digits in the displayed result.
4327	RW	0... 529	Device No 4: The result display position read out from the slave device register. The write of the value 0 causes the read-out stoppage (display) of the read-out result. The display position is defined as $Y.100 + x$ .
4328	RW	1...247	Device No 4: Slave device address
4329	RW	0...65535	Device No 4: Base address
4330	RW	1...10	Device No 4: Number of the register to display
4331	RW	1...10	Device No 4: Number of the register to display
4332	RW	0... 6	Device No 4: Register type: 0 - Variable of char type 1 - Variable of unsigned char type 2 - variable of integer type 3 - Variable of unsigned integer type 4 - Variable of long type 5 - Variable of unsigned long type 6 - Variable of float type
4333	RW	1... 60	Device No 4: review period in seconds. Defines the polling frequency of the slave device.

Register address	Operations	Range	Description
4334	RW	0... 3	Device No4: Number of places after the decimal point in the displayed result. 0 - lack of vdecimal point; 1 - one place after the decimal point; 2 - two places after the decimal point; 3 - three places after the decimal point.
4335	RW	3... 39	Device No 4: Forecasted number of characters placed on the display during the result display. Serves to clear the display in case of the decrease of number of digits in the displayed result.
4336	RW	0... 529	Device No 5: The result display position read out from the slave device register. The write of the value 0 causes the read-out stoppage (display) of the read-out result. The display position is defined as $Y.100 + x$ .
4337	RW	1...247	Device No 5: Slave device address
4338	RW	0...65535	Device No 5: Base address
4339	RW	1...10	Device No 5: Number of the register to display
4340	RW	1...10	Device No 5: Number of the register to display
4341	RW	0... 6	Device No 5: Register type: 0 - Variable of char type 1 - Variable of unsigned char type 2 - variable of integer type 3 - Variable of unsigned integer type 4 - Variable of long type 5 - Variable of unsigned long type 6 - Variable of float type
4342	RW	1... 60	Device No 5: review period in seconds. Defines the polling frequency of the slave device.
4343	RW	0... 3	Device No54: Number of places after the decimal point in the displayed result. 0 - lack of vdecimal point; 1 - one place after the decimal point; 2 - two places after the decimal point; 3 - three places after the decimal point.
4344	RW	3... 39	Device No 4: Forecasted number of characters placed on the display during the result display. Serves to clear the display in case of the decrease of number of digits in the displayed result.

**Note:** The write to the register 4265 causes the logic multiplication operation on the register, owing to this the erasing of single error and event flags is possible.

## Registers of graphical tables

Table 4

Register address	Operations	Range	Description
0	RW	0... 9	Number of graphical table on which the write/read-out operation is to be performed.
1	RW	0... 65535	Data of two first displayed columns in the shape: Column 1 - older byte Column 2 - younger byte
2	RW	0... 65535	Data of the second and third displayed column
· · ·	· · ·	0... 65535	
600	RW	1... 50	Data of columns No 1199 and 1200

**Note:** Data from graphical tables are divided on line and columns in the line. One byte represents one column in the line. The top of the column corresponds to the older bit in the byte.

The division on lines is carried out on the base of introduced quantity of the virtual DA1 panel dimension..

The position of the given column for displaying is therefore defined by the register with the index assigned on the base of the display panel dimensions.

## 8. TECHNICAL DATA

### Power consumption:

DA1-01	≤ 40 VA
DA1-02	≤ 72VA
DA1-03	≤ 40 VA
DA1-04	≤ 96VA

### Read-out field:

DA1-01	Text, 2 lines of 20 characters each
DA1-02	Text, 3 lines of 24 characters each
DA1-03	Graphical, 16 x 120 points
DA1-04	Graphical, 32 x 144 points

### Communication:

- serial interface (DA1 -> PC)	RS-485 and/or RS-232
- serial interface (DA1 -> measuring device)	RS-485
- transmission protocol	MODBUS RTU

### Reaction against decays and supply recoveries:

preservation of configuration data

### Protection grade ensured by the housing

IP 40

### Dimensions

depending on version (see table 1)

### Reference conditions and rated operating conditions:

- working temperature	0... <u>23</u> ...55°C
- storage temperature	-20... 75°C
- relative humidity	25... 95%
- voltage supply	100... <u>230</u> ...240 V a.c.
- frequency	45... <u>50</u> ...60 Hz
- external magnetic field	0... <u>40</u> ...400 A/m.
- working position	any

### Standards fulfilled by DA1 panels:

#### - electromagnetic compatibility:

- immunity	EN 61000-6-2
- emission	EN 61000-6-4
- resistance against supply decays	EN 61000-6-2

#### - safety requirements:

acc. to EN 61010-1 standard	
- insulation ensured by the housing	basic
- insulation between circuits	basic
- installation category	II
- pollution level	2
- maximal phase-to-earth working voltage:	
- for supply	600 V
- for interface circuit	50 V

## 9. ORDERING CODES

ALPHANUMERICAL DISPLAY PANEL	DA1 -	XX	X	X
<b>Panel type:</b>				
with text: 2 x 20 characters (character height h = 60 mm) .....		<b>01</b>		
with text: 3 x 24 characters (character height h = 60 mm) .....		<b>02</b>		
graphical 16 x 120 points.....		<b>03</b>		
graphical 32 x 144 points.....		<b>04</b>		
on order* .....		<b>XX</b>		
<b>Colour:</b>				
red .....			<b>R</b>	
green .....			<b>G</b>	
yellow.....			<b>Y</b>	
<b>Interface for programming:</b>				
RS-232 .....				<b>0</b>
RS-485 .....				<b>1</b>
RS-232 + RS-485 .....				<b>2</b>
Ethernet .....				<b>3</b>
Profibus DP .....				<b>4</b>
CAN .....				<b>5</b>

\*The version code is established by the manufacturer.

### Example of order:

The code **DA1 01 R 2** means:

- DA1** - alphanumerical display panel of DA1 type
- 01** - version with text: 2 x 20 characters and character height h= 60 mm
- R** - red colour displays
- 2** - with RS-232 and RS-485 interfaces

**Note:** It is possible to order a panel with built-in a lighting sensor.

## 10. BEFORE A FAILURE WILL BE DECLARED

In case of incorrect symptoms please acquaint with the table below.

Table 6

Symptoms	Procedure
1. After the panel turning on, not any segment is displayed.	Check the connection of the network cable.
2. Bargraph flickering in the place where the value from the external device is to be found.	Transmission error, check the connection A, B and settings of the read out device (slave configuration), if they are consistent with settings of the device co-operating with the display panel.
3. Bargraph flickering.	Erroneous quantity range (overflow of the declared number of digits to display).
4. Lack of reliability whether all character fields are efficient.	One must introduce a uniform graphics on the whole area of the read out field, and in case of abnormalities, contact an authorised workshop.
5. A result inconsistent with our expectations occurs on the readout field (result from the external device).	Check in „ Slave configuration” the register compatibility and the displayed register number.
6. The display panel does not establish communication with the computer through RS-485 or RS-232 interfaces.	Check the connection correctness and the correctness of introduced transmission parameters. In case, when the User does not remember the set up transmission parameters, one must turn the display panel off and turn it on again. During the start, currently set transmission parameters will be displayed.

## 11. MAINTENANCE AND WARRANTY

The DA1 display panel does not require any periodical maintenance.

During the display panel start, messages about errors can appear:

EE...Err

RAM...Err

RTC...Err

**Note:** the RTC..Err meaning the real time clock error, can be related with the lost of clock settings and requires the necessity to set the time. In case of the display of above messages one must contact the manufacturer's Service Department. Other messages are accessible according to agreements with the customer in custom-made versions.

In case of some incorrect operations:

### 1. After the dispatch date and within the period stated in the warranty card

One should return the display panel to the Quality Inspection Dept. If the display panel has been used in compliance with the instructions, we warrant to repair it free of charge.

The disassembling of the housing causes the cancellation of the granted warranty.

### 2. After the warranty period:

One should send the display panel to repair it in an authorized service workshop. Spare parts are available for the period of five years from the date of purchase.

**Our policy is one of continuous improvement and we reserve the right to make changes in design and specifications of any products as engineering advances or necessity requires and revise the above specifications without notice.**





**SALES PROGRAM**

- DIGITAL and BARGRAPH PANEL METERS
- MEASURING TRANSDUCERS
- ANALOG PANEL METERS (DIN INSTRUMENTS)
- ANALOG and DIGITAL CLAMP-ON METERS
- INDUSTRIAL and HOUSEHOLD CONTROLLERS
- CHART AND PAPERLESS RECORDERS
- POWER CONTROL UNITS and INVERTERS
- AUTOMOTIVE DASHBOARD INDICATORS
- ACCESSORIES FOR MEASURING INSTRUMENTS
- MEASURING SYSTEMS (ENERGY, HEAT, CONTROL)
- CUSTOM-MADE PRODUCTS

WE ALSO OFFER OUR SERVICES IN THE PRODUCTION OF:

- ALUMINIUM ALLOY PRESSURE CASTINGS
- PRECISION ENGINEERING AND THERMOPLASTICS PARTS

**QUALITY PROCEDURES:**

According to ISO 9001 and ISO 14001 international requirements.

All our instruments have CE mark.

For more information, please write to or phone our Export Department

DA1-07



Lubuskie Zakłady Aparatów  
Elektrycznych **LUMEL S.A.**  
ul. Sulechowska 1  
65-022 Zielona Góra - Po-  
land  
<http://www.lumel.com.pl>

Prodaja in zastopa:  
Materm d.o.o. Morje, morska cesta 6, 2313 Fram  
tel: 02 608 90 10, [www.materm.si](http://www.materm.si)

